

# SKKD 162, SKKE 162



**SEMIPACK<sup>®</sup> 2**

## Rectifier Diode Modules

**SKKD 162**

**SKKE 162**

### Features

- Heat transfer through aluminium oxide ceramic isolated metal baseplate
- Hard soldered joints for high reliability
- UL recognized, file no. E 63 532

### Typical Applications\*

- Non-controllable rectifiers for AC/AC converters
- Line rectifiers for transistorized AC motor controllers
- Field supply for DC motors

1) SKKD types only

$V_{RSM}$ V	$V_{RRM}$ V	$I_{FRMS} = 310$ A (maximum value for continuous operation) $I_{FAV} = 160$ A (sin. 180; $T_c = 95$ °C)	
900	800	SKKD 162/08	SKKE 162/08
1300	1200	SKKD 162/12	SKKE 162/12
1500	1400	SKKD 162/14	SKKE 162/14
1700	1600	SKKD 162/16	SKKE 162/16
1900	1800	SKKD 162/18	SKKE 162/18
2100	2000	SKKD 162/20H4	
2300	2200	SKKD 162/22H4	SKKE 162/22H4

Symbol	Conditions	Values	Units
$I_{FAV}$	sin. 180; $T_c = 85$ (100) °C	195 (150)	A
$I_D$	P3/180; $T_a = 45$ °C; B2 / B6	90 / 115	A
	P3/180F; $T_a = 35$ °C; B2 / B6	210 / 260	A
$I_{FSM}$	$T_{vj} = 25$ °C; 10 ms	6000	A
	$T_{vj} = 125$ °C; 10 ms	5000	A
$i^2t$	$T_{vj} = 25$ °C; 8,3 ... 10 ms	180000	A <sup>2</sup> s
	$T_{vj} = 125$ °C; 8,3 ... 10 ms	125000	A <sup>2</sup> s
$V_F$	$T_{vj} = 25$ °C; $I_F = 500$ A	max. 1,5	V
$V_{(TO)}$	$T_{vj} = 135$ °C	max. 0,85	V
$r_T$	$T_{vj} = 135$ °C	max. 1,2	mΩ
$I_{RD}$	$T_{vj} = 135$ °C; $V_{RD} = V_{RRM}$	max. 9	mA
$R_{th(j-c)}$	per diode / per module <sup>1)</sup>	0,18 / 0,09	K/W
$R_{th(c-s)}$	per diode / per module <sup>1)</sup>	0,1 / 0,05	K/W
$T_{vj}$		- 40 ... + 135	°C
$T_{stg}$		- 40 ... + 135	°C
$V_{isol}$	a. c. 50 Hz; r.m.s.; 1 s / 1 min.	3600 / 3000	V~
$V_{isol}$	a. c. 50 Hz; r.m.s.; 1 s / 1 min. for SKK ...H4	4800 / 4000	V~
$M_s$	to heatsink	5 ± 15 %	Nm
$M_t$	to terminals	5 ± 15 %	Nm
$a$		5 * 9,81	m/s <sup>2</sup>
$m$	approx.	165	g
Case	SKKD	A 23	
	SKKE	A 24	
	SKKE H4	A 54	

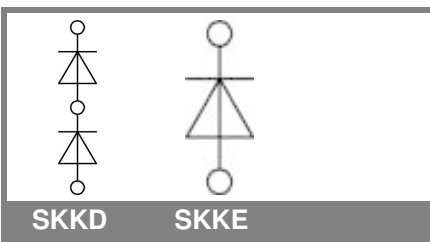

SKKD

SKKE

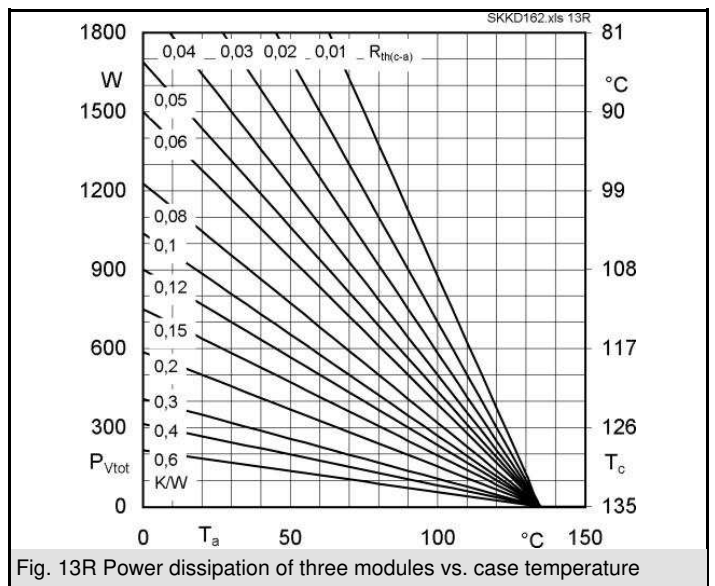
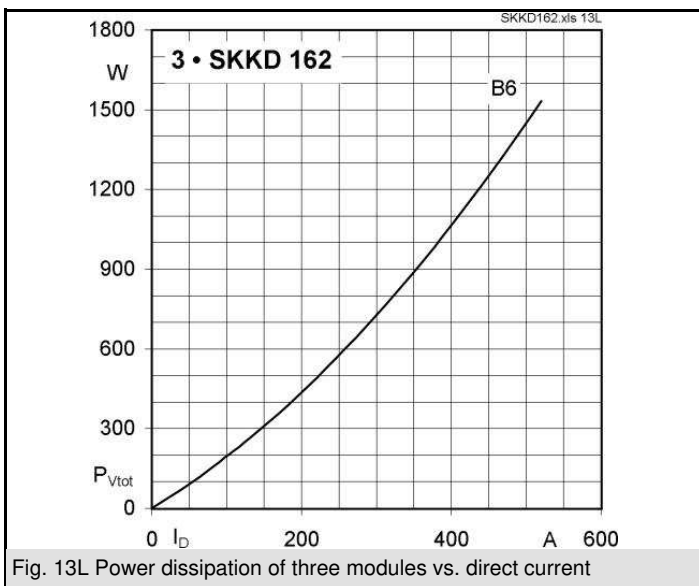
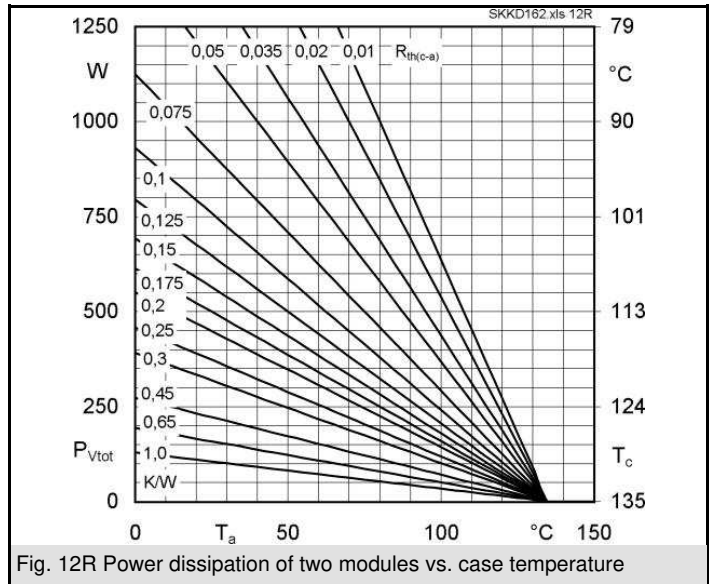
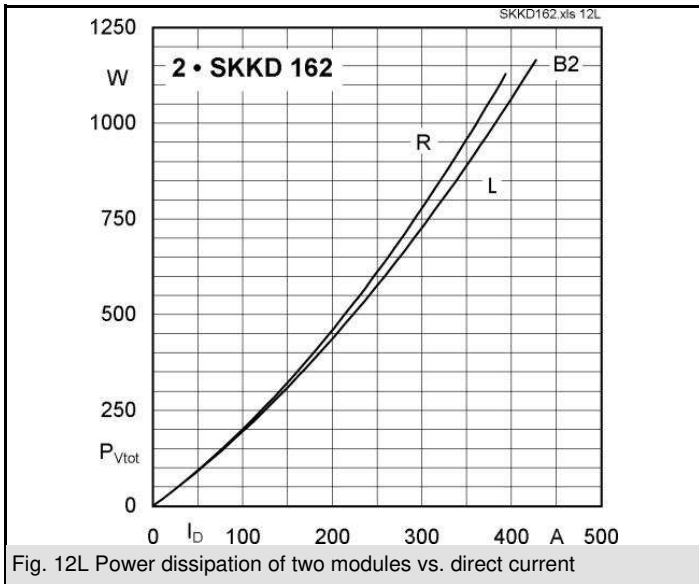
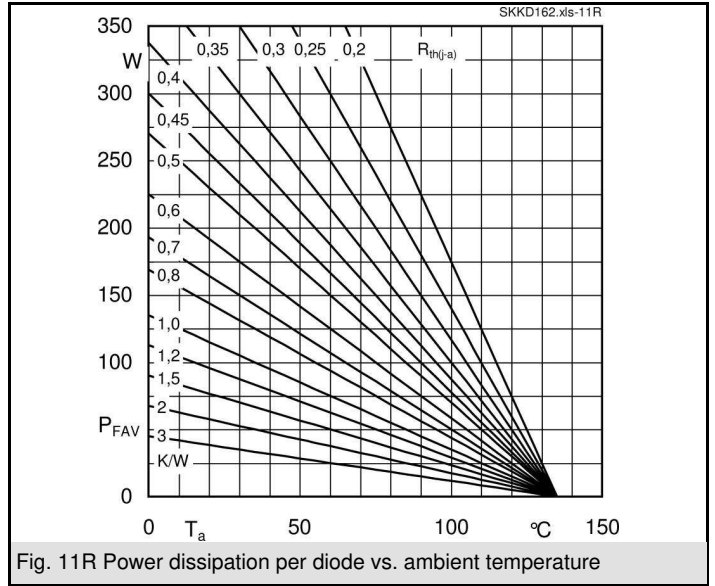
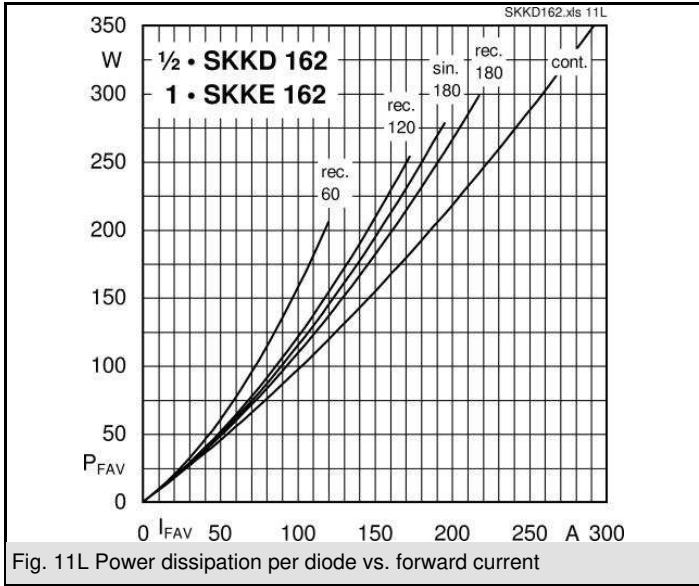

# SKKD 162, SKKE 162

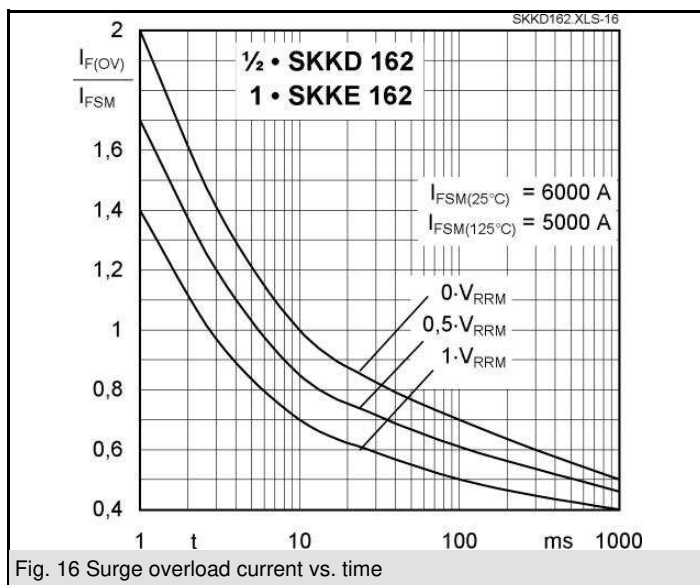
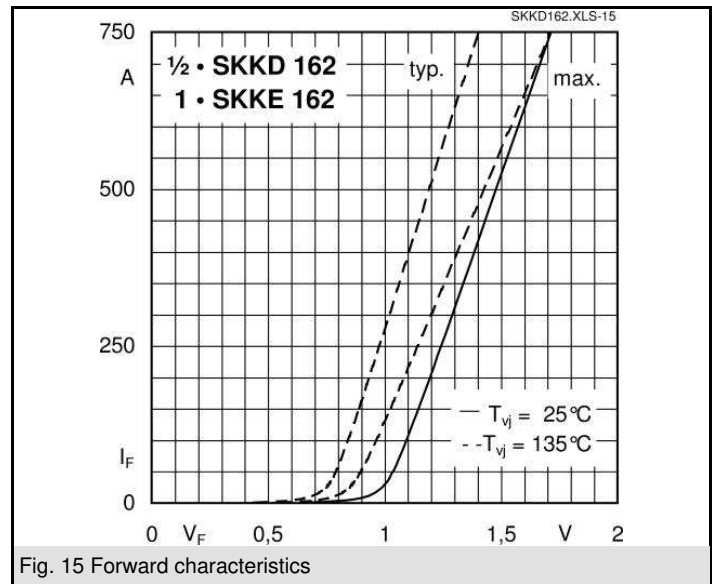
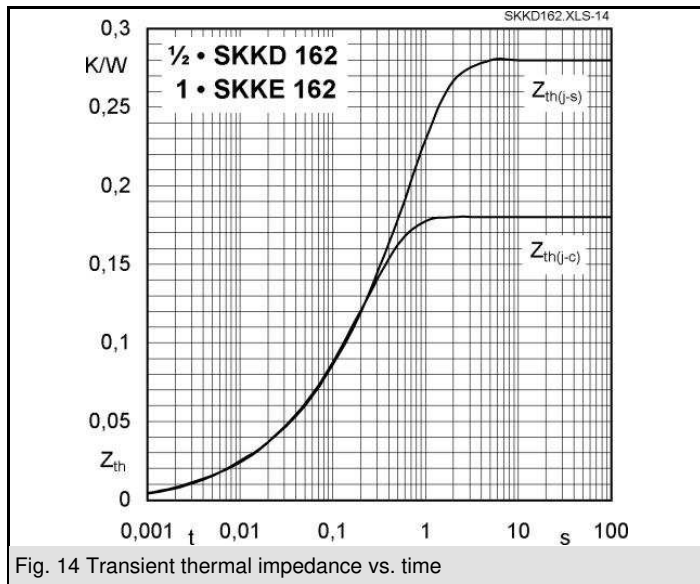

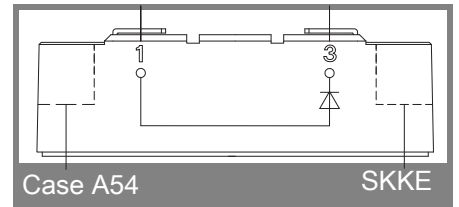
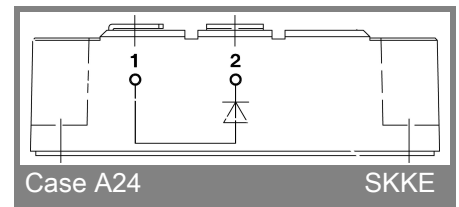
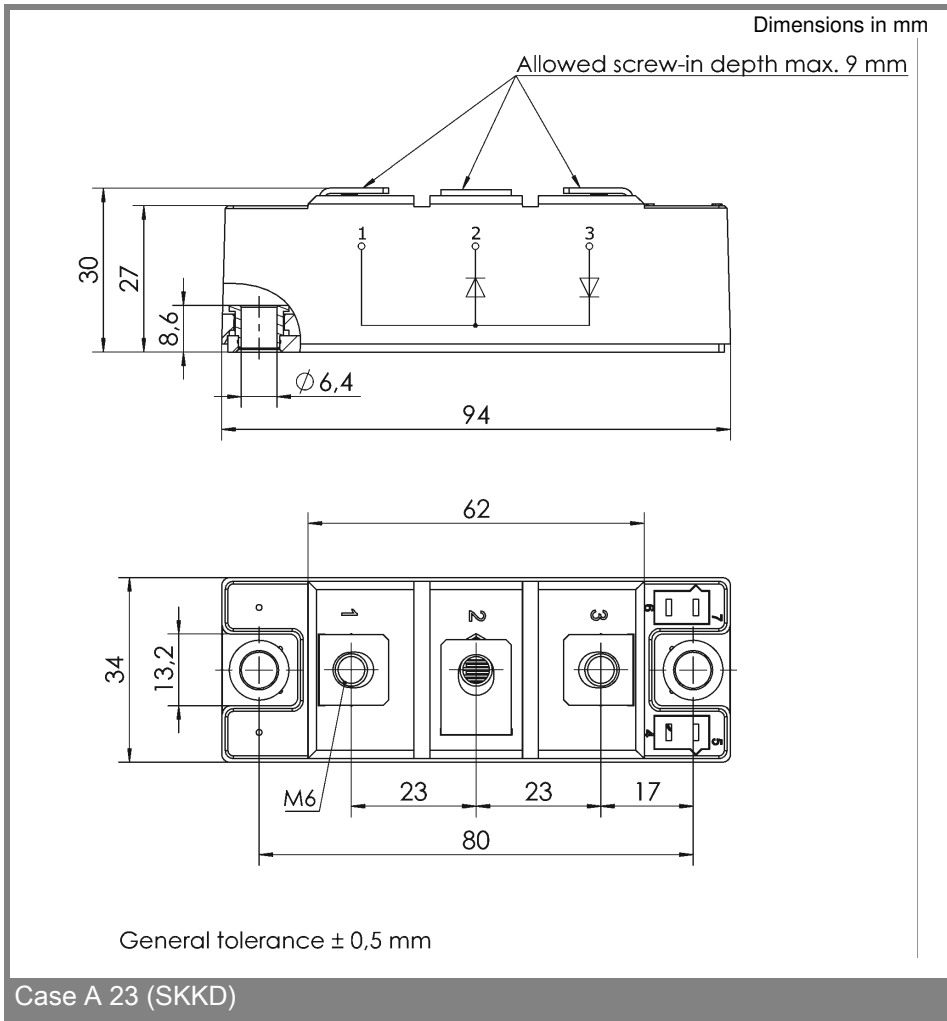

This is an electrostatic discharge sensitive device (ESDS) due to international standard IEC 61340.

**\*IMPORTANT INFORMATION AND WARNINGS**

The specifications of SEMIKRON products may not be considered as guarantee or assurance of product characteristics ("Beschaffheitsgarantie"). The specifications of SEMIKRON products describe only the usual characteristics of products to be expected in typical applications, which may still vary depending on the specific application. Therefore, products must be tested for the respective application in advance. Application adjustments may be necessary. The user of SEMIKRON products is responsible for the safety of their applications embedding SEMIKRON products and must take adequate safety measures to prevent the applications from causing a physical injury, fire or other problem if any of SEMIKRON products become faulty. The user is responsible to make sure that the application design is compliant with all applicable laws, regulations, norms and standards. Except as otherwise explicitly approved by SEMIKRON in a written document signed by authorized representatives of SEMIKRON, SEMIKRON products may not be used in any applications where a failure of the product or any consequences of the use thereof can reasonably be expected to result in personal injury. No representation or warranty is given and no liability is assumed with respect to the accuracy, completeness and/or use of any information herein, including without limitation, warranties of non-infringement of intellectual property rights of any third party. SEMIKRON does not assume any liability arising out of the applications or use of any product; neither does it convey any license under its patent rights, copyrights, trade secrets or other intellectual property rights, nor the rights of others. SEMIKRON makes no representation or warranty of non-infringement or alleged non-infringement of intellectual property rights of any third party which may arise from applications. Due to technical requirements our products may contain dangerous substances. For information on the types in question please contact the nearest SEMIKRON sales office. This document supersedes and replaces all information previously supplied and may be superseded by updates. SEMIKRON reserves the right to make changes.